

[超六类非屏蔽信息模块 LKE118-C6AU-A]

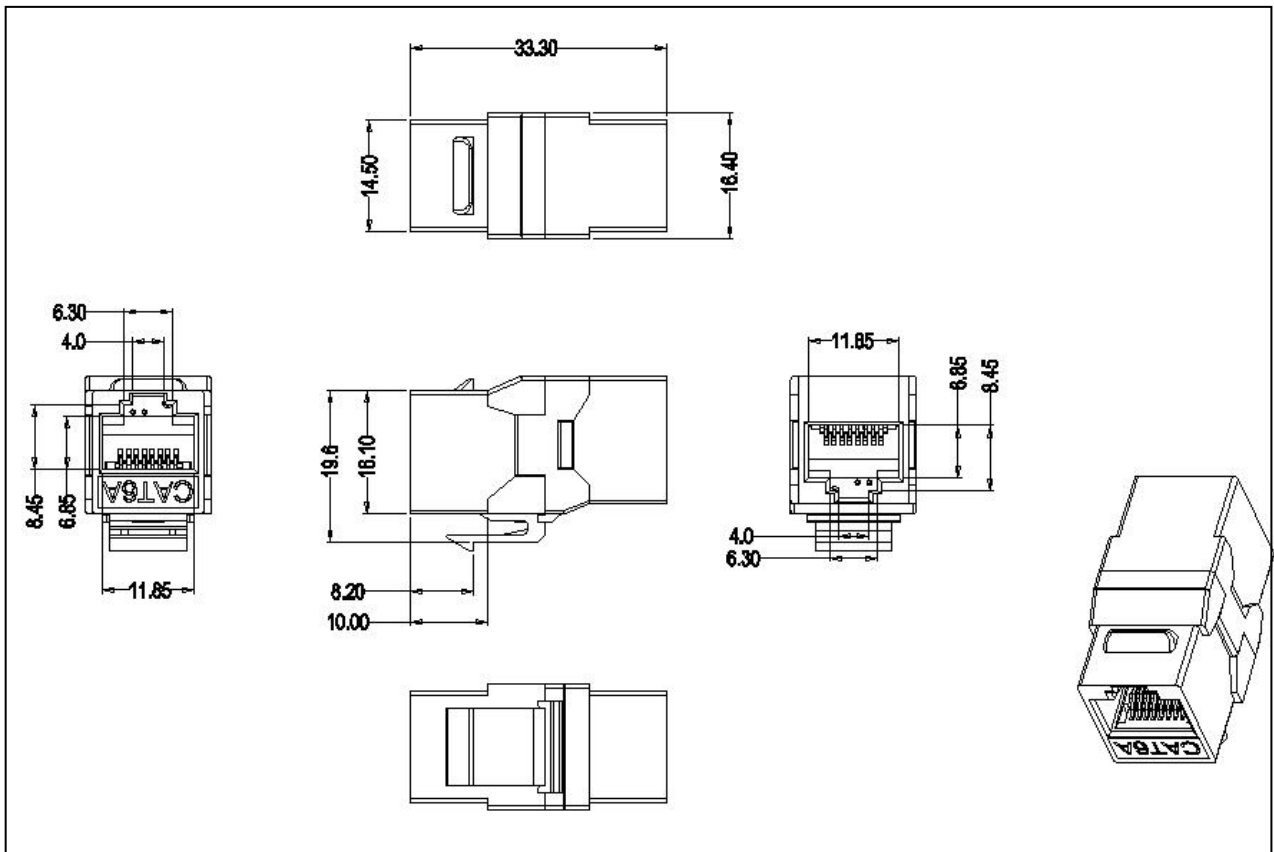

[产品结构图]



宁波多普勒通讯有限公司
Ningbo Doppler Communication Co., Ltd.

地址：浙江省余姚市经济开发区凤仪路86号
Address: No.86 fengyi road, economic development zone,
yuyao city, zhejiang province
E-mail : sale@dopplercabling.com
www.dopplercabling.com

业务热线：

联系人：杜先生 手机：13805807079
邮箱：duj@dopplercabling.com

[产品描述]

- 超六类非屏蔽对通信息模块超越了所有六类部件的性能要求，符合万兆以太网应用系统，适用于设备间与工作区的通讯插座连接，可提供高达 500MHz 的可用带宽

[技术特性]

- 自主的外观设计，简洁美观更紧凑
- 独特的 PCB 线路板线对平衡设计，减少干扰，通过余量高
- 端接口外壳材料采用高强度 PC 材料
- 接触针触点材料 50 μ ” 的镀金层，耐用性为 1500 次插拔
- 具有可向下兼容 CAT6 及更低类别的系统

[传输性能]

| 描述 | 描述 |
|----------|-------|
| 接触电阻（最大） | 20mΩ |
| 绝缘电阻（最小） | 500MΩ |
| 回波损耗（dB） | 4.2dB |

宁波多普勒通讯有限公司
Ningbo Doppler Communication Co., Ltd.

地址：浙江省余姚市经济开发区凤仪路86号
Address: No.86 fengyi road, economic development zone,
yuyao city, zhejiang province
E-mail : sale@dopplercabling.com
www.dopplercabling.com

业务热线：

联系人：杜先生 手机：13805807079

邮箱：duj@dopplercabling.com



[产品性能]



Cable ID: LKE118-C6AU
 Date / Time: 08/08/2018 03:40:50 PM
Headroom 4.5 dB (NEXT 36-45)
Test Limit: ISO11801 PL2 Class Ea
 Cable Type: Cat 6A U/UTP
 NVP: 68.2%

Software Version: V5.5 Build 2
 Limits Version: V6.3
 Calibration Start Date:
 Main (Module): 06/27/2018
 Remote (Module): 06/27/2018

Test Summary: PASS
 Model: DSX-8000
 Main S/N: 1820424
 Remote S/N: 1820428
 Main Adapter: DSX-PLA804
 Remote Adapter: DSX-PLA804

| | | |
|--------------------------------|-----------|-------|
| Length (ft), Limit 295 | [Pair 12] | 1 |
| Prop. Delay (ns), Limit 496 | [Pair 12] | 2 |
| Delay Skew (ns), Limit 43 | [Pair 12] | 0 |
| Resistance (ohms), Limit 20.60 | [Pair 45] | 0.22 |
| Insertion Loss Margin (dB) | [Pair 36] | 39.8 |
| Frequency (MHz) | [Pair 36] | 484.0 |
| Limit (dB) | [Pair 36] | 40.9 |

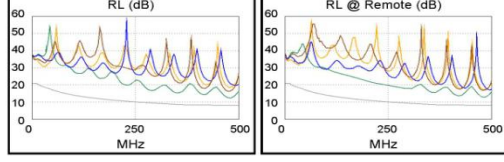
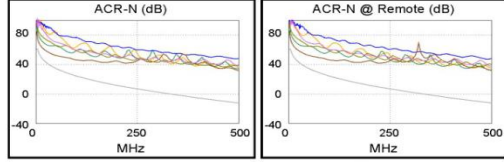
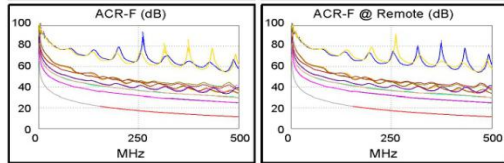
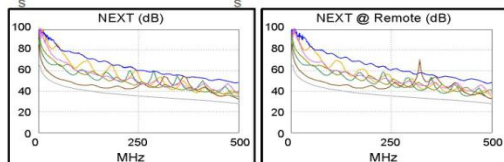
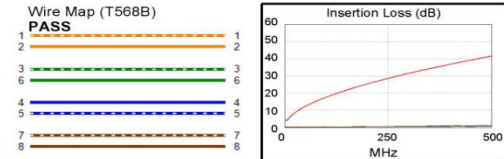
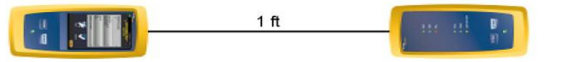

| | MAIN | SR | MAIN | SR |
|----------------------|-------------|-----------|-------------|-----------|
| Worst Pair | 36-45 | 36-45 | 36-45 | 36-45 |
| NEXT (dB) | 4.5 | 4.5 | 4.5 | 4.8 |
| Freq. (MHz) | 500.0 | 108.5 | 500.0 | 500.0 |
| Limit (dB) | 27.8 | 41.3 | 27.8 | 27.8 |
| Worst Pair | 36 | 45 | 45 | 45 |
| PS NEXT (dB) | 3.9 | 4.3 | 4.8 | 4.3 |
| Freq. (MHz) | 455.0 | 500.0 | 500.0 | 500.0 |
| Limit (dB) | 27.2 | 25.0 | 25.0 | 25.0 |
| PASS | MAIN | SR | MAIN | SR |
| Worst Pair | 12-45 | 12-45 | 12-45 | 12-45 |
| ACR-F (dB) | 13.4 | 13.4 | 13.7 | 13.6 |
| Freq. (MHz) | 5.9 | 5.0 | 496.0 | 500.0 |
| Limit (dB) | 49.9 | 51.3 | 11.3 | 11.3 |
| Worst Pair | 45 | 45 | 45 | 45 |
| PS ACR-F (dB) | 15.1 | 15.1 | 15.3 | 15.1 |
| Freq. (MHz) | 5.9 | 500.0 | 500.0 | 500.0 |
| Limit (dB) | 46.9 | 8.3 | 8.3 | 8.3 |
| N/A | MAIN | SR | MAIN | SR |
| Worst Pair | 36-45 | 36-45 | 36-45 | 36-45 |
| ACR-N (dB) | 13.9 | 14.0 | 44.0 | 44.3 |
| Freq. (MHz) | 6.0 | 7.8 | 500.0 | 500.0 |
| Limit (dB) | 57.1 | 54.8 | -12.4 | -12.4 |
| Worst Pair | 45 | 45 | 45 | 45 |
| PS ACR-N (dB) | 15.6 | 15.7 | 44.4 | 43.9 |
| Freq. (MHz) | 6.0 | 7.3 | 500.0 | 500.0 |
| Limit (dB) | 54.8 | 53.1 | -15.3 | -15.3 |
| N/A | MAIN | SR | MAIN | SR |
| Worst Pair | 36 | 36 | 36 | 36 |
| RL (dB) | 4.2 | 4.7 | 4.2 | 4.7 |
| Freq. (MHz) | 480.0 | 483.0 | 480.0 | 483.0 |
| Limit (dB) | 8.0 | 8.0 | 8.0 | 8.0 |

Compliant Network Standards:
 10BASE-T 100BASE-TX 100BASE-T4
 1000BASE-T 10GBASE-T ATM-25
 ATM-S1 ATM-155 100VG-AnyLan
 TR-4 TR-16 Active TR-16 Passive

Project: DEFAULT

JKE18-XLB-UC6-UC6A(2018.08.008).flw



[订购信息]

| 型号 | 名称 | 标准颜色 | 小包装 | 大包装 | 外箱尺寸 (L×W×H) | 重量 |
|---------------|--------------|------|-------|--------|-------------------|--------|
| LKE118-C6AU-A | 超六类非屏蔽对通信息模块 | 黑色 | 50PCS | 500PCS | 53cm× 31cm × 23cm | 4.80KG |

宁波多普勒通讯有限公司
 Ningbo Doppler Communication Co., Ltd.

地址：浙江省余姚市经济开发区凤仪路86号
 Address: No.86 fengyi road, economic development zone,
 yuyao city, zhejiang province
 E-mail : sale@dopplercabling.com
 www.dopplercabling.com

业务热线：

联系人：杜先生 手机：13805807079
 邮箱：duj@dopplercabling.com

